

Dati Tecnici Travel Box / Technical Data Travel Box

Modello Model	Capacità lorda Gross capacity	Dimensioni HxLxP mm Dimensions HxWxD mm	Peso Weight	Potenza installata Installed power	Tensione Voltage	Sistema refrigerante Cooling system
TB31A NEW	30 L	380 x 350 x 585	16 Kg	45 Watt	12-24/115-230 Volt	Danfoss BD35F ventilated
TB41A NEW	40 L	445 x 350 x 585	17 Kg	45 Watt	12-24/115-230 Volt	Danfoss BD35F ventilated
TB51A NEW	50 L	530 x 350 x 585	18,5 Kg	50 Watt	12-24/115-230 Volt	Danfoss BD35F ventilated
TB45A	45 L	475 x 550 x 490	19 Kg	45 Watt	12-24/115-230 Volt	Danfoss BD35F ventilated
TB55A	55 L	515 x 670 x 530	22,5 Kg	45 Watt	12-24/115-230 Volt	Danfoss BD35F ventilated
TB42	42 L	440 x 415 x 630	20 Kg	60 Watt	12-24 Volt	Danfoss BD35F ventilated
TB42A	42 L	440 x 415 x 630	21,5 Kg	60 Watt	12-24/115-230 Volt	Danfoss BD35F ventilated
TB25AM	25 L	219 x 554 x 451	12 Kg	60 Watt	12-24 Volt	Danfoss BD35F ventilated
TB20	20 L	476 x 426 x 250	15 Kg	60 Watt	12-24 Volt	Danfoss BD35F ventilated
TB2001	26 L	380 x 345 x 580	16 Kg	60 Watt	12-24 Volt	Danfoss BD35F ventilated
TB36	35,5 L	250 x 440 x 715	16 Kg	60 Watt	12-24 Volt	Danfoss BD35F ventilated
FRIGOCAT	7 L	430 x 160 x 276	6 Kg	50 Watt	12 or 24 Volt	Thermoelectric (Peltier)

Dati riferiti a temperatura ambiente 32°C / 89,6°F
Above figures taken with ambient temperature of 32°C / 89,6°F.

Indel B si riserva il diritto di modificare le caratteristiche tecniche e di design senza preavviso
Design and specifications are subject to modification without notice.



Travel Box

Frigoriferi portatili 12/24-115/230V
12/24-115/230V portable refrigerators



Località Cà Baldone - 47866 Sant'Agata Feltria (Rn) - Italy - Tel. +39 0541 848711 - Fax +39 0541 848000
marketing@indelb.com - www.indelb.com

Studio PrimoPiano - Ad. giuseppina.deci@alice.it - Ph. Leon - Stampa CDPress - 10/2010



Let it B cool. Everywhere.

sleeping Well

12 o 24V
parking air conditioning



☆☆☆☆☆
indel B
gruppo BERLONI

www.indelb.com

Travel Box
frigoriferi 12/24V



Indel B impiega circa 200 dipendenti; la sede e gli stabilimenti produttivi (13.000 mq coperti) sono localizzati a Sant'Agata Feltria in provincia di Rimini.

Indel B è azienda leader a livello mondiale nella produzione di minibar per albergo.

L'offerta di Indel B è completata dall'importante produzione di aria condizionata e frigoriferi a corrente continua per barche da diporto, veicoli industriali e ricreativi, e da una nuova gamma di cantine refrigerate per vini rossi e bianchi.

Indel B employs approximately 200 production and administrative staff. The head office and production sites (covering 13.000 square metres) are located at Sant'Agata Feltria in the province of Rimini. Indel B is a world leader in the production of minibar fridges for hotels. Indel B also produces air conditioning and a wide range of fridge for other markets, including direct current refrigerators for pleasure boats and industrial and recreational vehicles as well as a new range of cellar refrigerators for both red and white wines.



Il gruppo Berloni, fondato nel 1960 dai fratelli Antonio e Marcello Berloni, è oggi una grande realtà industriale di respiro internazionale, che ha nei mobili per la casa il suo core business ed è in significativo sviluppo anche in altri settori. Impiega circa 1000 persone ripartite in 3 business unit: unit casa, unit ufficio e unit freddo di cui Indel B è l'azienda leader.

Le principali linee di prodotto sono: cucine componibili, arredamento per la casa, mobili per ufficio, componenti per la refrigerazione e naturalmente frigoriferi di piccole dimensioni. La sua produzione viene esportata in tutto il mondo.

The Berloni Group, founded in 1960 by the Berloni brothers Antonio and Marcello, is today a great international industrial reality, with home furnishing as its core business in addition to its' significant developments in many other areas. The principal product lines include component kitchens, home furniture, office furniture, refrigeration components and naturally the Indel B fridges.

Berloni Group employs approximately 1000 people within 3 business units: home unit, office unit and cold unit of which Indel B is the leader company. Products of Berloni Group are exported worldwide.

■ I nuovi modelli TB31A, TB41A e TB51A offrono il meglio della tecnologia elettronica. Compressore Danfoss altamente efficiente, funzione risparmio energetico (ECO), funzione turbo (MAX) e termostato elettronico multifunzione consentono una facile ed economica gestione del frigorifero attraverso un controllo ed una riduzione dei consumi. La Centralina Danfoss, consente di alimentare il frigorifero a 12-24Volt (DC) oppure a 115-230 Volt (AC). La commutazione tra corrente continua e corrente alternata avviene automaticamente. Tre livelli di protezione della batteria di serie.

■ The new TB31A, TB41A and TB51A models feature the best of electronic technology. Highly efficient Danfoss compressors, energy saving function (ECO), turbo function (MAX) and multifunction electronic thermostat allow an easy and economic management of the fridge through a check and a reduction of consumptions. The electronic board, AC/DC Danfoss converter, allows a DC12-24 Volt or an AC 115-230 Volt supply. The switching between DC and AC is automatic. Three battery protection levels as standard.



Termostato elettronico con lettura della temperatura a display, funzione risparmio energetico (ECO) e funzione turbo (MAX).

Electronic thermostat with display reading temperature, Energy saving function (ECO) and high speed function (MAX).



Nuovo coperchio robusto ad iniezione con sistema di chiusura integrato.

New sturdy injection moulded lid with integrated closing system.



Dati Tecnici

Technical Data

Capacità lorda: 30 L
 Dimensioni esterne: h x l x p
 380 mm x 350 mm x 585 mm
 Dimensioni interne: h x l x p
 290 mm x 270 mm x 315 mm
 Dimensioni imballo: h x l x p
 423 mm x 383 mm x 618 mm
 Volume imballo: (m³) 0,1
 Peso: 16 Kg + 1,5 kg imballo
 Potenza installata: 45 Watt
 Tensione: DC 12-24 Volt e AC 115-230 Volt / 50-60Hz
 Temperatura d'esercizio*: +10°C/-18°C
 Sistema refrigerante:
 DANFOSS BD35F ventilato
 Gas Refrigerante: R134a CFC FREE
 Accumulo di freddo: No
 Kit di fissaggio: Sì
 Isolamento: CFC FREE PU FOAM
 Luce interna: Sì

Gross capacity: 30 L
 External dimensions: h x w x d
 380 mm x 350 mm x 585 mm
 Internal dimensions : h x w x d
 290 mm x 270 mm x 315 mm
 Packing dimensions: h x w x d
 423 mm x 383 mm x 618 mm
 Packing volume: (m³) 0,1
 Weight: 16 Kg + 1,5 kg packing
 Installed power: 45 Watt
 Voltage: DC 12-24 Volt and AC 115-230 Volt / 50-60 Hz
 Operation Temperature*: +10°C/-18°C
 Cooling system:
 DANFOSS BD35F ventilated
 Refrigerant: R134a CFC FREE
 Cold build-up system: No
 Fixing kit: Yes
 Insulation: CFC FREE PU FOAM
 Internal light: Yes

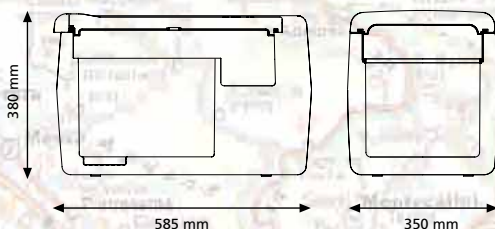

*Temperatura ambiente a + 32°C / Ambient temperature at +32°C

■ I nuovi modelli TB31A, TB41A e TB51A offrono il meglio della tecnologia elettronica. Compressore Danfoss altamente efficiente, funzione risparmio energetico (ECO), funzione turbo (MAX) e termostato elettronico multifunzione consentono una facile ed economica gestione del frigorifero attraverso un controllo ed una riduzione dei consumi. La Centralina Danfoss, consente di alimentare il frigorifero a 12-24Volt (DC) oppure a 115-230 Volt (AC). La commutazione tra corrente continua e corrente alternata avviene automaticamente. Tre livelli di protezione della batteria di serie.

■ The new TB31A, TB41A and TB51A models feature the best of electronic technology. Highly efficient Danfoss compressors, energy saving function (ECO), turbo function (MAX) and multifunction electronic thermostat allow an easy and economic management of the fridge through a check and a reduction of consumptions. The electronic board, AC/DC Danfoss converter, allows a DC12-24 Volt or an AC 115-230 Volt supply. The switching between DC and AC is automatic. Three battery protection levels as standard.



Cestino interno estraibile fornito standard. Massima capienza: può contenere bottiglie fino a 1,5 litri in posizione verticale.

Pull-out inner basket supplied as standard. Maximum capacity: it can contain bottles up to 1,5 litres in vertical position.



Nuovo coperchio robusto ad iniezione con sistema di chiusura integrato e solide maniglie da trasporto di facile applicazione.

New injection moulded lid integrating the new ergonomic lid closing system. Easy mounting strong carrying handles



Termostato elettronico con lettura della temperatura a display, funzione risparmio energetico (ECO) e funzione turbo (MAX).

Electronic thermostat with display reading temperature, Energy saving function (ECO) and high speed function (MAX).



Dati Tecnici

Technical Data

Capacità lorda: 40 L
 Dimensioni esterne: h x l x p
 445 mm x 350 mm x 585 mm (700 con maniglie)
 Dimensioni interne: h x l x p
 355 mm x 270 mm x 315 mm
 Dimensioni imballo: h x l x p
 478 mm x 383 mm x 618 mm
 Volume imballo: (m³) 0,113
 Peso: 17 Kg + 1,5 kg imballo
 Potenza installata: 45 Watt
 Voltage: DC 12-24 Volt and AC 115-230 Volt - 50/60 Hz
 Temperatura d'esercizio*: +10/-18°C
 Sistema refrigerante:
 DANFOSS BD35F ventilato
 Gas Refrigerante: R134a CFC FREE
 Accumulo di freddo: No
 Kit di fissaggio: su richiesta
 Isolamento: CFC FREE PU FOAM
 Luce interna: Sì

Gross capacity: 40 L
 External dimensions: h x w x d
 445 mm x 350 mm x 585 mm (700 with handles)
 Internal dimensions: h x w x d
 355 mm x 270 mm x 315 mm
 Packing dimensions: h x w x d
 478 mm x 383 mm x 618 mm
 Packing volume: (m³) 0,113
 Weight: 17 Kg + 1,5 kg packing
 Installed power: 45 Watt
 Voltage: DC 12-24 Volt and AC 115-230 Volt - 50/60 Hz
 Operation Temperature*: +10/-18°C
 Cooling system:
 DANFOSS BD35F ventilated
 Refrigerant: R134a CFC FREE
 Cold build-up system: No
 Fixing kit: Optional
 Insulation: CFC FREE PU FOAM
 Internal light: Yes

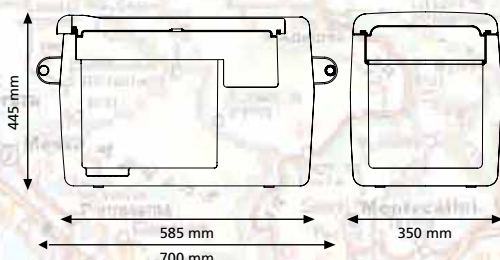

*Temperatura ambiente a + 32°C / Ambient temperature at +32°C

■ I nuovi modelli TB31A, TB41A e TB51A offrono il meglio della tecnologia elettronica. Compressore Danfoss altamente efficiente, funzione risparmio energetico (ECO), funzione turbo (MAX) e termostato elettronico multifunzione consentono una facile ed economica gestione del frigorifero attraverso un controllo ed una riduzione dei consumi. La Centralina Danfoss, consente di alimentare il frigorifero a 12-24Volt (DC) oppure a 115-230 Volt (AC). La commutazione tra corrente continua e corrente alternata avviene automaticamente. Tre livelli di protezione della batteria di serie.

■ *The new TB31A, TB41A and TB51A models feature the best of electronic technology. Highly efficient Danfoss compressors, energy saving function (ECO), turbo function (MAX) and multifunction electronic thermostat allow an easy and economic management of the fridge through a check and a reduction of consumptions. The electronic board, AC/DC Danfoss converter, allows a DC12-24 Volt or an AC 115-230 Volt supply. The switching between DC and AC is automatic. Three battery protection levels as standard.*



Cestino interno estraibile fornito standard. Massima capienza: può contenere anche bottiglie da 1,5 litri in posizione verticale.

Pull-out inner basket supplied as standard. Maximum capacity: it can also contain 1,5 litres bottles in vertical position.



Nuovo coperchio robusto ad iniezione con sistema di chiusura integrato e solide maniglie da trasporto di facile applicazione.

New injection moulded lid integrating the new ergonomic lid closing system. Easy mounting strong carrying handles



Termostato elettronico con lettura della temperatura a display, funzione risparmio energetico (ECO) e funzione turbo (MAX).

Electronic thermostat with display reading temperature, Energy saving function (ECO) and high speed function (MAX).



Dati Tecnici

Technical Data

Capacità lorda: 50 L
 Dimensioni esterne: h x l x p
 530 mm x 350 mm x 585 mm (700 con maniglie)
 Dimensioni interne: h x l x p
 440 mm x 270 mm x 315 mm
 Dimensioni imballo: h x l x p
 573 mm x 383 mm x 618 mm
 Volume imballo: (m³) 0,136
 Peso: 18,5 Kg + 2 kg imballo
 Potenza installata: 50 Watt
 Tensione: DC 12-24 Volt / AC 115-230 Volt / 50-60 Hz
 Temperatura d'esercizio*: +10/-18°C
 Sistema refrigerante:
 DANFOSS BD35F ventilato
 Gas Refrigerante: R134a CFC FREE
 Accumulo di freddo: No
 Kit di fissaggio: su richiesta
 Isolamento: CFC FREE PU FOAM
 Luce interna: Sì

*Gross capacity: 50 L
 External dimensions: h x w x d
 530 mm x 350 mm x 585 mm (700 with handles)
 Internal dimensions: h x w x d
 440 mm x 270 mm x 315 mm
 Packing dimensions: h x w x d
 573 mm x 383 mm x 618 mm
 Packing volume: (m³) 0,136
 Weight: 18,5 Kg + 2 kg packing
 Installed power: 50 Watt
 Voltage: DC 12-24/ Volt / AC 115-230 Volt / 50-60 Hz
 Operation Temperature*: +10/-18°C
 Cooling system:
 DANFOSS BD35F ventilated
 Refrigerant: R134a CFC FREE
 Cold build-up system: No
 Fixing kit: Optional
 Insulation: CFC FREE PU FOAM
 Internal light: Yes*

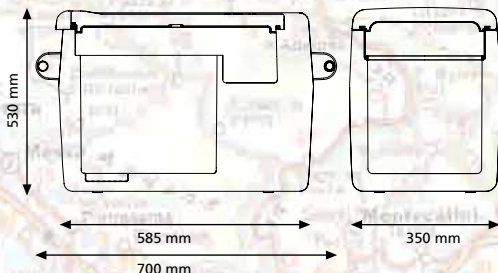

*Temperatura ambiente a +32°C / Ambient temperature at +32°C

■ Il TB45A offre il meglio della tecnologia elettronica. Funzione risparmio energetico (ECO), funzione turbo (MAX) e termostato elettronico multifunzione consentono una facile ed economica gestione del frigorifero attraverso un controllo ed una riduzione dei consumi. La Centralina Danfoss fornita di serie, consente di alimentare il frigorifero a 12-24Volt (DC) oppure a 115-230 Volt (AC). La commutazione tra corrente continua e corrente alternata avviene automaticamente. Tre livelli di protezione della batteria di serie. Grazie al suo importante isolamento è anche un ottimo freezer. Le maniglie sono integrate nel frigorifero e il kit di installazione è fornito di serie.

■ *The TB45A offers the best of electronic technology. Energy saving function (ECO), turbo function (MAX) and multifunction electronic thermostat allow an easy and economic management of the fridge through a check and a reduction of consumptions. The standard electronic board AC/DC Danfoss converter allows a DC12-24 Volt or an AC 115-230 Volt supply. The switching between DC and AC is automatic. Three battery protection levels as standard. Thanks to its important insulation it is also a good freezer. The handles are integrated in the cabinet fridge and the fixing kit is standard.*



Massima capienza: può contenere anche bottiglie da 1,5 litri in posizione verticale.

Maximum capacity: it can also contain 1,5 litres bottles in vertical position.



Porta lattine/bottiglie sulla parte superiore del frigorifero.

Can/bottle holder on the upper surface of the fridge.



Termostato elettronico con lettura della temperatura a display, funzione risparmio energetico (ECO) e funzione turbo (MAX).

Electronic thermostat with display reading temperature, Energy saving function (ECO) and high speed function (MAX).

Danfoss

Dati Tecnici

Technical Data

Capacità lorda: 45 L
 Dimensioni esterne: h x l x p
 475 mm x 550 mm x 490 mm
 Dimensioni interne: h x l x p
 370 mm x 410 mm x 245 mm
 Dimensioni imballo: h x l x p
 525 mm x 580 mm x 530 mm
 Volume imballo: (m³) 0,161
 Peso: 19 Kg + 2 kg imballo
 Potenza installata: 45 Watt
 Tensione: DC 12-24 Volt e AC 115-230 Volt
 Temperatura d'esercizio*: +5°C/-18°C
 Sistema refrigerante:
 DANFOSS BD35F ventilato
 Gas Refrigerante: R134a CFC FREE
 Accumulo di freddo: No
 Kit di fissaggio: Sì
 Isolamento: CFC FREE PU FOAM
 Luce interna: No

Gross capacity: 45 L
 External dimensions: h x w x d
 475 mm x 550 mm x 490 mm
 Internal dimensions: h x w x d
 370 mm x 410 mm x 245 mm
 Packing dimensions: h x w x d
 525 mm x 580 mm x 530 mm
 Packing volume: (m³) 0,161
 Weight: 19 Kg + 2 kg packing
 Installed power: 45 Watt
 Voltage: DC 12-24 Volt and AC 115-230 Volt
 Operation Temperature*: +5°C/-18°C
 Cooling system:
 DANFOSS BD35F ventilated
 Refrigerant: R134a CFC FREE
 Cold build-up system: No
 Fixing kit: Yes
 Insulation: CFC FREE PU FOAM
 Internal light: No

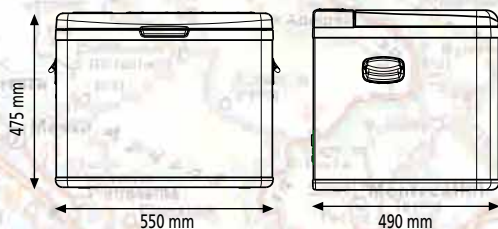

*Temperatura ambiente a + 32°C / Ambient temperature at +32°C

■ Il nuovo TB55A offre il meglio della tecnologia elettronica. Funzione risparmio energetico (ECO), funzione turbo (MAX) e termostato elettronico multifunzione consentono una facile ed economica gestione del frigorifero attraverso un controllo ed una riduzione dei consumi. La Centralina Danfoss fornita di serie, consente di alimentare il frigorifero a 12-24Volt (DC) oppure a 115-230 Volt (AC). La commutazione tra corrente continua e corrente alternata avviene automaticamente. Tre livelli di protezione della batteria di serie. La sua capienza è massima, può contenere anche bottiglie da 1,5 litri in posizione verticale. Grazie al suo importante isolamento è anche un ottimo freezer.

■ *The new TB55A offers the best of electronic technology. Energy saving function (ECO), turbo function (MAX) and multifunction electronic thermostat allow an easy and economic management of the fridge through a check and a reduction of consumptions. The standard electronic board AC/DC Danfoss converter allows a DC12-24 Volt or an AC 115-230 Volt supply. The switching between DC and AC is automatic. Three battery protection levels as standard. It has a great capacity: it can also contain 1,5 litres bottles in vertical position. Thanks to its thick insulation it is also a good freezer.*



Maniglie integrate nel frigo e kit di fissaggio in dotazione.

Handles integrated in the cabinet fridge and fixing kit as standard.



Termostato elettronico con lettura della temperatura a display, funzione risparmio energetico (ECO) e funzione turbo (MAX).

Electronic thermostat with display reading temperature, Energy saving function (ECO) and high speed function (MAX).



Porta lattine/bottiglie sulla parte superiore del frigorifero.

Can/bottle holder on the upper surface of the fridge.

Dati Tecnici

Technical Data

Capacità lorda: 55 L
 Dimensioni esterne: h x l x p
 515 mm x 670 mm x 530 mm
 Dimensioni interne: h x l x p
 365 mm x 470 mm x 224 mm
 Dimensioni imballo: h x l x p
 570 mm x 700 mm x 580 mm
 Volume imballo: (m³) 0,231
 Peso: 22,5 Kg + 4 kg imballo
 Potenza installata: 45 Watt
 Tensione: DC 12-24 Volt e AC 115-230 Volt
 Temperatura d'esercizio*: +5°C/-18°C
 Sistema refrigerante:
 DANFOSS BD35F ventilato
 Gas Refrigerante: R134a CFC FREE
 Accumulo di freddo: No
 Kit di fissaggio: Sì
 Isolamento: CFC FREE PU FOAM
 Luce interna: No

*Gross capacity: 55 L
 External dimensions: h x w x d
 515 mm x 670 mm x 530 mm
 Internal dimensions: h x w x d
 365 mm x 470 mm x 224 mm
 Packing dimensions: h x w x d
 570 mm x 700 mm x 580 mm
 Packing volume: (m³) 0,231
 Weight: 22,5 Kg + 4 kg packing
 Installed power: 45 Watt
 Voltage: DC 12-24 Volt and AC 115-230 Volt
 Operation Temperature*: +5°C/-18°C
 Cooling system:
 DANFOSS BD35F ventilated
 Refrigerant: R134a CFC FREE
 Cold build-up system: No
 Fixing kit: Yes
 Insulation: CFC FREE PU FOAM
 Internal light: No*

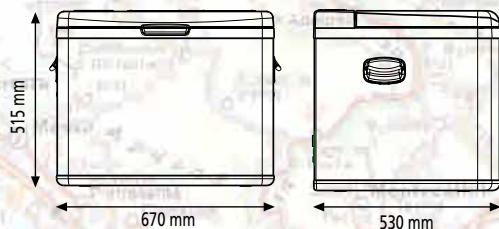

*Temperatura ambiente a +32°C / Ambient temperature at +32°C

■ Frigorifero professionale a 12-24 Volt (e 115-230 Volt - versione TB42A) dal design innovativo. Cabinet in rotomoulding per una massima robustezza. Il doppio coperchio consente un uso ergonomico del prodotto permettendo una guida attenta e sicura. Il coperchio è inoltre removibile rendendo il frigorifero veramente versatile. Termostato elettronico multifunzione (TB42A). La Centralina Danfoss, fornita di serie nel modello TB42A, consente di alimentare il frigorifero a 12-24Volt (DC) oppure a 115-230 Volt (AC). La commutazione tra corrente continua e corrente alternata avviene automaticamente.

■ Innovative designed professional DC12-24 Volt fridge (and AC115-230 Volt - model TB42A). Rotomoulded cabinet for the utmost strength. The double lid allows an ergonomic use of the product for a careful and safe driving. The lid is also detachable making the fridge really versatile. Multifunction electronic thermostat (TB42A). The electronic board AC/DC Danfoss converter, standard with TB42A, allows a DC12-24 Volt or an AC 115-230 Volt supply. The switching between DC and AC is automatic.



Solide maniglie da trasporto di facile applicazione.

Easy mounting strong carrying handles.



Modello esclusivo con secondo coperchio di servizio integrato per una guida sicura.

Exclusive model with integrated second small lid for a safe driving.



Kit di fissaggio in dotazione.

Fixing kit as standard.

Danfoss

Dati Tecnici

Technical Data

Capacità lorda: 42 L
 Dimensioni esterne: h x l x p
 440 mm x 415 mm x 630 mm
 Dimensioni interne: h x l x p
 315 mm x 320 mm x 260 mm
 Dimensioni imballo: h x l x p
 475 mm x 420 mm x 666 mm
 Volume imballo: (m³) 0,133
 Peso: TB42, 20 Kg + 1,5 kg imballo
 Peso: TB42A, 21,5 Kg + 1,5 kg imballo
 Potenza installata: 60 Watt
 Tensione: DC 12-24 Volt e AC 115-230 Volt TB42A
 Temperatura d'esercizio*: +5°C/-12°C
 Conformità EMC: Sì
 Sistema refrigerante: DANFOSS BD35F ventilato
 Gas Refrigerante: R134a CFC FREE
 Accumulo di freddo: Sì
 Kit di fissaggio: Sì (standard)
 Isolamento: CFC FREE PU FOAM
 Luce interna: No

Gross capacity: 42 L
 External dimensions: h x w x d
 440 mm x 415 mm x 630 mm
 Internal dimensions: h x w x d
 315 mm x 320 mm x 260 mm
 Packing dimensions: h x w x d
 475 mm x 420 mm x 666 mm
 Packing volume: (m³) 0,133
 TB42 weight 20 Kg + 1,5 kg packing
 TB42A weight 21,5 Kg + 1,5 kg packing
 Installed power: 60 Watt
 Voltage: DC 12-24 Volt and AC 115-230 Volt TB42A
 Operation Temperature*: +5°C/-12°C
 EMC conformity: Si
 Cooling system: DANFOSS BD35F ventilated
 Refrigerant: R134a CFC FREE
 Cold build-up system: Yes
 Fixing kit: Yes (standard)
 Insulation: CFC FREE PU FOAM
 Internal light: No

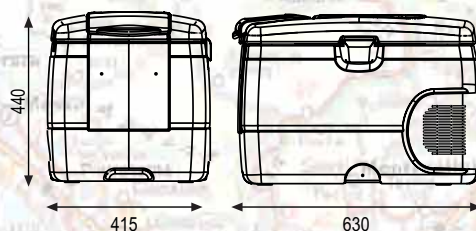

Altre Caratteristiche: Termostato elettronico (TB42A) con lettura della temperatura a display
 Further main features: Electronic thermostat (TB42A) with display reading temperature
 *Temperatura ambiente a +32°C / Ambient temperature at +32°C

■ TB25AM, è il frigorifero a compressore di Indel B per l'installazione di primo impianto su Actros (Mercedes).

Si colloca sotto il lettino del conducente, nel cassetto originale, lasciando quindi maggiore spazio all'interno della cabina del camion. L'installazione è facile e rapida.

■ TB25AM is the Indel B compressor refrigerator for the Original Equipment installation in the Actros (Mercedes).

It fits under the bunk in the sleeping compartment, inside the original drawer, thus leaving more space in the truck cab. The installation is easy and quick.



Gruppo refrigerante con sistema antiribaltamento.

Cooling system including tilt cab protection.



Termostato manuale e luce interna.

Manual Thermostat and internal light.



Cerniere magnetiche per una chiusura ermetica.

Magnetic hinges for hermetic seal.

Danfoss

Dati Tecnici

Technical Data

Capacità lorda: 25 L
 Dimensioni esterne: h x l x p
 219 mm x 554 mm x 451 mm
 Dimensioni interne: h x l x p
 165 mm x 405 mm x 220 mm
 Dimensioni imballo: h x l x p
 225 mm x 620 mm x 495 mm
 Volume imballo: (m³) 0,069
 Peso: 12 Kg + 2,6 kg imballo
 Potenza installata: 60 Watt
 Tensione: DC 12-24 Volt
 Temperatura d'esercizio*: +10°C/0°C
 Sistema refrigerante:
 DANFOSS BD35F ventilato
 Gas Refrigerante: R134a CFC FREE
 Accumulo di freddo: No
 Kit di fissaggio: Sì (standard)
 Isolamento: CFC FREE PU FOAM
 Luce interna: Sì

Gross capacity: 25 L
 External dimensions: h x w x d
 219 mm x 554 mm x 451 mm
 Internal dimensions: h x w x d
 165 mm x 405 mm x 220 mm
 Packing dimensions: h x w x d
 225 mm x 620 mm x 495 mm
 Packing volume: (m³) 0,069
 Weight: 12 Kg + 2,6 kg packing
 Installed power: 60 Watt
 Voltage: DC 12-24 Volt
 Operation Temperature*: +10°C/0°C
 Cooling system:
 DANFOSS BD35F ventilated
 Refrigerant: R134a CFC FREE
 Cold build-up system: No
 Fixing kit: Sì (standard)
 Insulation: CFC FREE PU FOAM
 Internal light: Yes

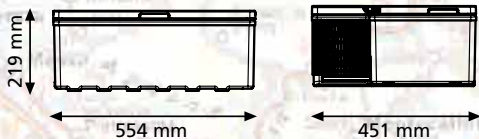

*Temperatura ambiente a +32°C / Ambient temperature at +32°C

■ Questo frigo, progettato per essere incassato sotto il letto, è la soluzione ideale per aumentare lo spazio abitabile nella cabina dei veicoli industriali.

■ This unit has been designed to fit under the bunk in the sleeping compartment of long distance commercial vehicles. The sliding drawer arrangement then gives the driver access to the contents without losing valuable space in the cab.



Gruppo refrigerante con sistema antiribaltamento.

Cooling system including tilt cab protection.



Contenitore interno estraibile.

Pull-out inner basket.



Termostato manuale facilmente accessibile.

Easy manual thermostat.

Danfoss

Dati Tecnici

Technical Data

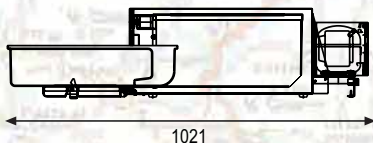

1021

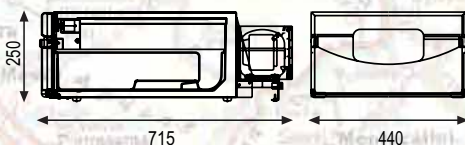

250

715

440

Capacità lorda: 35,5 L
 Dimensioni esterne: h x l x p
 250 mm x 440 mm x 715 mm
 Dimensioni interne: h x l x p
 165 mm x 335 mm x 400 mm
 Dimensioni imballo: h x l x p
 300 mm x 520 mm x 740 mm
 Volume imballo: (m³) 0,115
 Peso 16,0 kg + 3,4 kg imballo
 Potenza installata: 60 Watt
 Tensione: DC 12-24 Volt
 Temperatura d'esercizio*: +10°C/-4°C
 Conformità: EMC Si
 Sistema refrigerante: DANFOSS BD35F ventilato
 Gas Refrigerante: R134a CFC FREE
 Accumulo di freddo: No
 Kit di fissaggio: Si (standard)
 Isolamento: CFC FREE PU FOAM
 Luce interna: Si

Gross capacity: 35,5 L
 External dimensions: h x w x d
 250 mm x 440 mm x 715 mm
 Internal dimensions: h x w x d
 165 mm x 335 mm x 400 mm
 Packing dimensions: h x w x d
 300 mm x 520 mm x 740 mm
 Packing volume: (m³) 0,115
 Weight: 16,0 kg + 3,4 kg packing
 Installed power: 60 Watt
 Voltage: DC 12-24 Volt
 Operation Temperature*: +10°C/-4°C
 EMC conformity: Yes
 Cooling system: DANFOSS BD35F ventilated
 Refrigerant: R134a CFC FREE
 Cold build-up system: No
 Fixing kit: Yes (standard)
 Insulation: CFC FREE PU FOAM
 Internal light: Yes

*Temperatura ambiente a +32°C / Ambient temperature at +32°C

FRIGOCAT è stato progettato per essere installato negli spazi più stretti, risultando così il compagno ideale nei trattori, furgoni, veicoli movimento terra ed automobili.

Contrariamente ai termoelettrici conosciuti, FRIGOCAT è un vero e proprio frigorifero capace di raggiungere la temperatura interna di 2°C con una temperatura esterna di 32°C.

FRIGOCAT has been designed to be fitted in the narrowest available space and is ideal for use in tractors, vans, trucks, and cars.

As opposed to most other thermoelectric systems which are little more than cold boxes, the FRIGOCAT is a real refrigerator capable of reaching a temperature of 2°C even with an external temperature of 32°C.

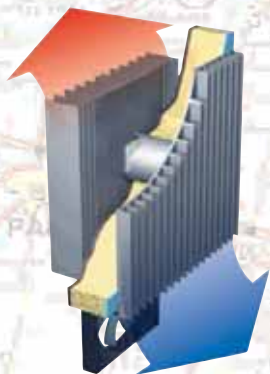

Sistema refrigerante termoelettrico (Peltier) ad altissima efficienza (ΔT 30°C).

High efficient thermoelectric (Peltier) cooling system (ΔT 30°C).



Compatto ma progettato per contenere due bottiglie da due litri.

Compact design. It can hold 2x2 liter bottles.



Kit di fissaggio fornito in dotazione.

Fixing kit as standard.

Danfoss

Dati Tecnici

Technical Data

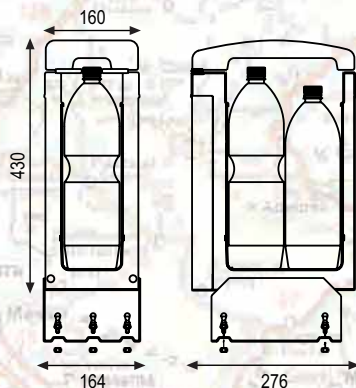

Capacità lorda: 7 L
 Dimensioni esterne: h x l x p
 430 mm x 160 mm x 276 mm
 Dimensioni interne: h x l x p
 335 mm x 80 mm x 175 mm
 Dimensioni imballo: h x l x p
 455 mm x 190 mm x 305 mm
 Volume imballo: (m³) 0,027
 Peso: 6 kg + 1 kg imballo
 Potenza installata: 50 Watt
 Tensione: DC 12-24 Volt
 Temperatura d'esercizio*: +2°C
 Conformità EMC: Sì
 Sistema refrigerante: Termoelettrico (Peltier)
 Gas Refrigerante: Senza Gas
 Accumulo di freddo: No
 Kit di fissaggio: Sì (standard)
 Isolamento: CFC FREE PU FOAM
 Luce interna: No

Gross capacity: 7 L
 External dimensions: h x w x d
 430 mm x 160 mm x 276 mm
 Internal dimensions: h x w x d
 335 mm x 80 mm x 175 mm
 Packing dimensions: h x w x d
 455 mm x 190 mm x 305 mm
 Packing volume: (m³) 0,027
 Weight: 6 kg + 1 kg packing
 Installed power: 50 Watt
 Voltage: DC 12 -24 Volt
 Operation Temperature*: +2°C
 EMC conformity Yes
 Cooling system: Thermoelectric (Peltier)
 Refrigerant: No Gas
 Cold build-up system: No
 Fixing kit: Yes (standard)
 Insulation: CFC FREE PU FOAM
 Internal light: No

*Temperatura ambiente a +32°C / Ambient temperature at +32°C

■ Il TB 20 è utilizzato spesso, grazie alle sue particolari dimensioni ed alla sua solidità, come base d'appoggio per salire sul letto superiore della cabina dei veicoli industriali.

Trova un ottimo utilizzo, installato a lato dell'autista, anche nei pullman turistici.

Il TB20 è disponibile a richiesta anche nella versione 12/24 115/230 e termostato elettronico per uso elettromedicale.

■ *This unit is used extensively in long distance commercial vehicles and coaches and, because of its size and strength, is often used as a step for the driver to gain access to the upper bunk.*

The TB20 is also available on request at 12/24 115/230 V with electronic thermostat for the Electro Medical market.



Unico frigorifero sviluppato in altezza per gli spazi più stretti.

Tall and narrow fridge for limited spaces on vehicles.



Cerniere magnetiche per una chiusura ermetica.

Magnetic hinges for hermetic seal.



Coperchio resistente utilizzabile come base d'appoggio per accedere al letto superiore.

Strong lid exploitable as a step to gain access to the upper bunk.

Danfoss

Dati Tecnici

Capacità lorda: 20 L
 Dimensioni esterne: h x l x p
 476 mm x 426 mm x 250 mm
 Dimensioni interne: h x l x p
 420 mm x 150 mm x 150 mm
 Dimensioni imballo: h x l x p
 550 mm x 490 mm x 315 mm
 Volume imballo: (m³) 0,084
 Peso: 15,0 kg + 1,8 kg imballo
 Potenza installata: 60 Watt
 Tensione: DC 12-24 Volt
 Temperatura d'esercizio*: +2°C/+10°C
 Conformità EMC: Sì
 Sistema refrigerante: DANFOSS BD35F ventilato
 Gas Refrigerante: R134a CFC FREE
 Accumulo di freddo: Sì
 Kit di fissaggio Sì: (standard)
 Isolamento: CFC FREE PU FOAM
 Luce interna: No

Technical Data

Gross capacity: 20 L
 External dimensions: h x w x d
 476 mm x 426 mm x 250 mm
 Internal dimensions: h x w x d
 420 mm x 150 mm x 150 mm
 Packing dimensions: h x w x d
 550 mm x 490 mm x 315 mm
 Packing volume: (m³) 0,084
 Weight: 15,0 kg + 1,8 kg packing
 Installed power: 60 Watt
 Voltage: DC 12-24 Volt
 Operation Temperature*: +2°C/+10°C
 EMC conformity: Yes
 Cooling system: DANFOSS BD35F ventilated
 Refrigerant: R134a CFC FREE
 Cold build-up system: Yes
 Fixing kit: Yes (standard)
 Insulation: CFC FREE PU FOAM
 Internal light: No

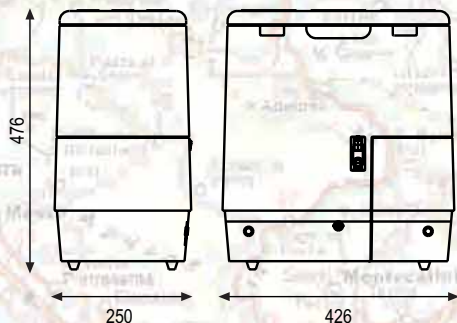

*Temperatura ambiente a + 32°C / Ambient temperature at +32°C

■ Design, solidità e bassissimi consumi fanno di questo frigorifero l'inimitabile compagno di viaggio. Nato per essere installato in un veicolo industriale, può agevolmente essere spostato nel week-end in auto, in barca o nei veicoli ricreativi. Il TB2001 è uno dei frigoriferi per camion più venduto negli ultimi anni. Il TB2001 è disponibile a richiesta anche nella versione 12/24 115/230 e termostato elettronico per uso elettromedicale.

■ *Its design, strength and low power consumption make this fridge the essential travel mate for all journeys. Although designed initially for commercial transport it is also used extensively in cars, boats and other recreational vehicles. TB2001 is one of the most purchased refrigerator for trucks in the last years. The TB2001 is also available on request at 12/24 115/230 V with electronic thermostat for the Electro Medical market.*



Coperchio con incavo per alloggiare bottiglie da due litri.

Lid with recess to hold 2x2 litres bottles.



Luce interna e accumulo di freddo di serie.

Inner light and cold build-up system as standard.



Pannello di controllo con termostato manuale e interruttore on-off di facile accesso.

Easy control panel with manual thermostat and on-off switch.

Danfoss

Dati Tecnici

Technical Data

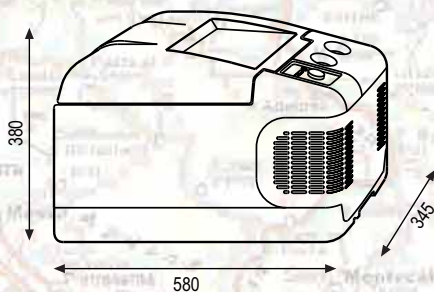

Capacità lorda: 26 L
 Dimensioni esterne: h x l x p
 380 mm x 345 mm x 580 mm
 Dimensioni interne: h x l x p
 245 mm x 205 mm x 310 mm
 Dimensioni imballo: h x l x p
 420 mm x 380 mm x 620 mm
 Volume imballo: (m³) 0,098
 Peso: 16,0 kg + 2,6 kg imballo
 Potenza installata: 60 Watt
 Tensione: DC 12-24 Volt
 Temperatura d'esercizio*: +5°C/-12°C
 Conformità EMC: Sì
 Sistema refrigerante: DANFOSS BD35F ventilato
 Gas Refrigerante: R134a CFC FREE
 Accumulo di freddo: Sì
 Kit di fissaggio: Sì (option)
 Isolamento: CFC FREE PU FOAM
 Luce interna: Sì

Gross capacity: 26 L
 External dimensions: h x w x d
 380 mm x 345 mm x 580 mm
 Internal dimensions: h x w x d
 245 mm x 205 mm x 310 mm
 Packing dimensions: h x w x d
 420 mm x 380 mm x 620 mm
 Packing volume: (m³) 0,098
 Weight: 16,0 kg + 2,6 kg packing
 Installed power: 60 Watt
 Voltage: DC 12-24 Volt
 Operation Temperature*: +5°C/-12°C
 EMC conformity: Yes
 Cooling system: DANFOSS BD35F ventilated
 Refrigerant: R134a CFC FREE
 Cold build-up system: Yes
 Fixing kit: Yes (option)
 Insulation: CFC FREE PU FOAM
 Internal light: Yes

*Temperatura ambiente a +32°C / Ambient temperature at +32°C

OEM PRODUCTS

Indel B SpA è azienda leader nella produzione di frigoriferi a corrente continua 12/24 Volt sul mercato OEM e AFTERMARKET. Indel B SpA collabora da anni con le maggiori case produttrici di Veicoli Industriali e Pullman producendo per essi frigoriferi personalizzati o fornendo frigoriferi standard.



Indel B SpA is the leading company for the production of 12/24 Volt DC refrigerators both for the OEM and the AFTERMARKET. Indel B SpA have been cooperating for many years with major industrial vehicle, bus and coach builders, producing for them standard and customized built fridges.



IVECO



DAF

